



Cover photo Leighton Linen with Pewter Glaze

NEW PRODUCT INTRODUCTION

CABINET SPECIFICATIONS & PRICING ADDENDUM

Armstrong[®] | CABINETS
www.armstrongcabinets.com

Trademark owned by AWI Licensing Company and is used by permission.

©2013 AWI Licensing Company SPECADDENDUM 10/13
Printed in the United States of America

NOTICE: The product specifications appearing herein supersede and cancel all previous sheets, supplements and addenda, and represent current manufacturing standards and procedures. Armstrong Cabinet Products reserves the right to make specification changes for continued product improvement.
For aesthetic considerations the furniture and cabinet industries have made veneer on composite panel substrate the standard method of construction for raised panel-in-frame doors in some wood species. Within the Armstrong Cabinet Products product line, those species include oak, birch and maple.

Photo shown on front cover –Leighton™ Linen with Pewter Glaze



Armstrong Cabinets is part of the Kitchen Cabinet Manufacturers Association (KCMA) and the National Kitchen and Bath Association (NKBA). Armstrong cabinetry carries the ANSI/KCMA A161.1 quality assurance certification.

LINEN FINISH

MAPLE & BIRCH
DOOR STYLES

LINEN

- Soft white hue that compliments a variety of colors and décor
- Use as a base for any of our hand applied glazes
- "True Enamel" paint finish gives your cabinets a smooth and clean finish
- Available on Maple and Birch door styles and accessories, except Novara
- Available with Premier and Allwood Construction series



Linen



Linen Brown Glaze



Linen Caramel Glaze



Linen Frost Glaze



Linen Pewter Glaze



Linen Taupe Glaze

SALES TOOLS

SAMPLES

NEW

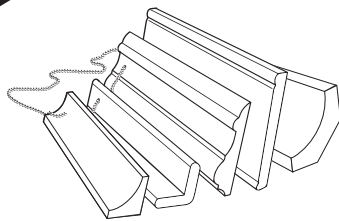

MOLDING CHAINS | \$175

- 61 total molding pieces on two chains; must be purchased as full set
- Accent Molding on Chain #1
- Crown and Light Rail on Chain #2

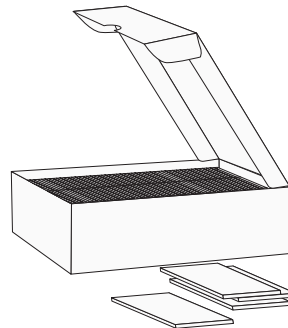

WOOD CHIP SET | \$300

- 71 wood chip samples in Stain, Stain/Glaze, Paint and Paint/Glaze colors
- Single Wood Chips Samples are available
- Oak, Maple, and Cherry samples only
- Use Maple for Birch and Cherry for Alder color samples

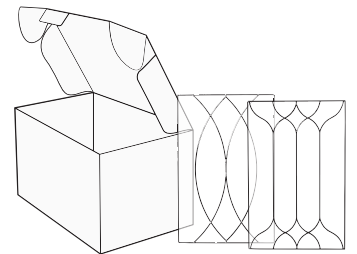

GLASS SAMPLE BOX | \$120

- 14 glass samples in 4"x4" size and 7 leaded glass samples in 6"x8" size
- 21 total glass samples come in two boxes
- Contains all our current glass insert offerings

CHB8S

MOLDINGS

MAPLE USED WHEN ORDERING BIRCH

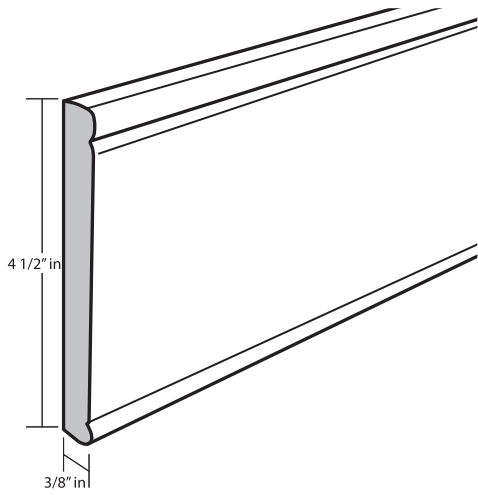

CHAIR RAIL BACKER

- Solid Oak, Maple, Cherry or Alder
- Glaze finish available
- Can be used alone or with CHR8S insert

CHB8S

CHR8S

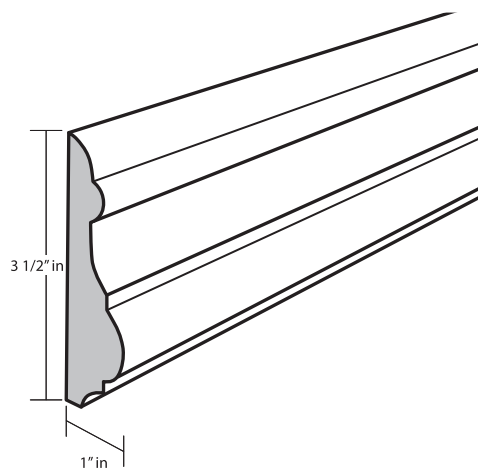

CHAIR RAIL MOLDING

- Solid Oak, Maple, Cherry or Alder
- Glaze finish available
- Can be used alone or as an insert for CHB8S backer

CHR8S

LOCM8S

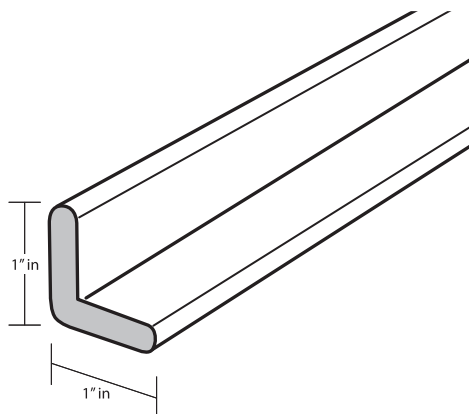

LARGE OUTSIDE CORNER MOLDING

- Solid Oak, Maple, or Cherry
- Not available in glaze finish

LOCM8S

NEW GLASS INSERTS

MORE STYLES TO CHOOSE FROM

Many new glass inserts now available for both Standard and Full Overlay door Styles.

Glass inserts are for use with Alder, Birch, Cherry and Maple door styles. Not for use with Novara, Calibra II and Shasta.



Town Square

- Obscure Frosted Etch Glass
- 3/8" Etched Grooved Intersecting X
- Available in Cut for Glass door
- Recommended for use with square door styles only



Woven

- White Woven Grid design laminated between two pieces of clear glass
- Available in Cut for Glass door



Clear Bevel

- 1/4" Bevel
- Clear Tempered Glass
- Available in Cut for Glass door



Saddle

- Obscure Glass
- Leather Paper laminated between two pieces of glass
- Available in Cut for Glass or Mullion Door

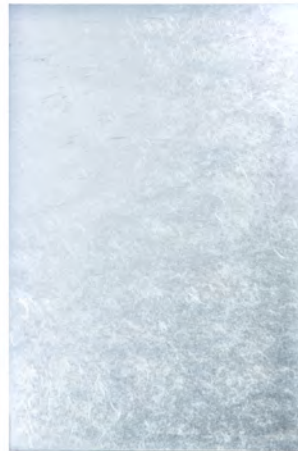

Shanghai

- Obscure Glass
- Rice Paper laminated between two pieces of glass
- Available in Cut for Glass or Mullion Door



Silver Screen

- Silver Screen
- Aluminum Wire Grid Screen laminated between clear glass
- Available in Cut for Glass door or Mullion Door

DISCONTINUED GLASS INSERT STYLES

In order to bring you the most current line of glass insert stylings, the following are no longer available: Cross Reeded, Thin Reeded, V-Grooved, Frost Etch (light), Star and Diamond.

BLACKENED ZINC CAMING

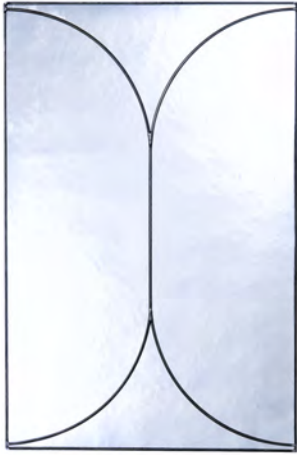

Vintage Patina

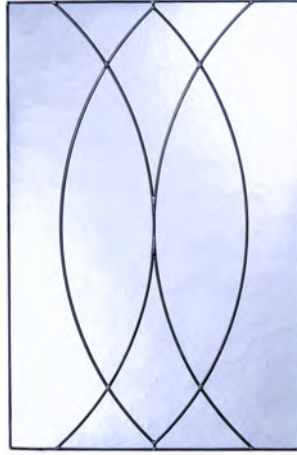

Victorian Patina

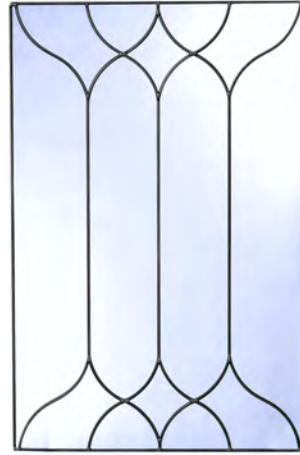

Windsor Zinc

- Camed Artique Clear Glass
- Available in Cut for Glass door
- Recommend for square door styles only

NEW GLASS INSERTS

BLACKENED OR POLISHED ZINC CAMING

Many new glass inserts now available for both Standard and Full Overlay door Styles.

Glass inserts are for use with Alder, Birch, Cherry and Maple door styles. Not for use with Novara, Calibra II and Shasta.

POLISHED ZINC CAMING

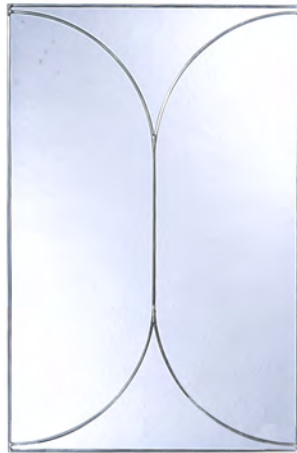

Vintage Zinc



Victorian Zinc

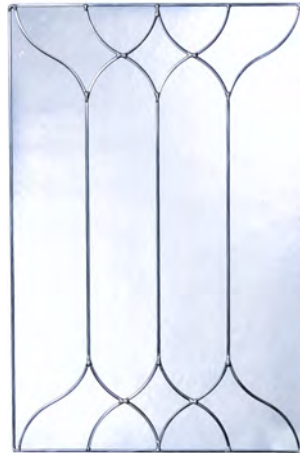

Windsor Zinc

- Camed Artique Clear Glass
- Available in Cut for Glass door
- Recommend for square door styles only



REFLECTIONS

- Mirrored Glass
- Available in Cut for Glass door or Mullion Door

www.armstrongcabinets.com

DOOR STYLE	GLASS INSERT STYLES																	
	Artique	Baroque	Clear	Clear Bevel	Frost Etch (Medium)	Glue Chip	Rain	Reeded	Reflections	Saddle	Seedy	Shanghai	Silver Screen	Town Square	Windsor (Patina or Zinc)	Woven	Victorian (Patina or Zinc)	Vintage (Patina or Zinc)
Arborcrest	M, D	M, D	M, D	D	M, D, V	M, D	M, D	D	M, D	M, D	M, D	M, D	M, D	D	D	D	D	D
Berkshire	M, D	M, D	M, D	D	M, D	M, D	M, D	D	M, D	M, D	M, D	M, D	M, D	D	D	D	D	D
Berkshire Arch	M, D	M, D	M, D	D	M, D	M, D	M, D	D	M, D	M, D	M, D	M, D	M, D	-	-	D	-	-
Branford	M, D	M, D	M, D	D	M, D	M, D	M, D	D	M, D	M, D	M, D	M, D	M, D	D	D	D	D	D
Calibra II	-	-	-	-	V	-	-	-	-	-	-	-	-	-	-	-	-	-
Caruth	M, D	M, D	M, D	D	M, D	M, D	M, D	D	M, D	M, D	M, D	M, D	M, D	D	D	D	D	D
Cimarron	M, D	M, D	M, D	D	M, D	M, D	M, D	D	M, D	M, D	M, D	M, D	M, D	D	D	D	D	D
Coronet	-	-	-	-	-	-	-	-	-	-	-	-	-	-	-	-	-	-
Hampton	M, D	M, D	M, D	D	M, D	M, D	M, D	D	M, D	M, D	M, D	M, D	M, D	D	D	D	D	D
Hampton Arch	M, D	M, D	M, D	D	M, D	M, D	M, D	D	M, D	M, D	M, D	M, D	M, D	-	-	D	-	-
LaCerise	M, D	M, D	M, D	D	M, D, V	M, D	M, D	D	M, D	M, D	M, D	M, D	M, D	D	D	D	D	D
LaCerise Arch	M, D	M, D	M, D	D	M, D, V	M, D	M, D	D	M, D	M, D	M, D	M, D	M, D	-	-	D	-	-
Leighton	D	D	D	D	D, V	D	D	D	D	D	D	D	D	D	D	D	D	D
Mayfair	D	D	D	D	D, V	D	D	D	D	D	D	D	D	D	D	D	D	D
Newbury	D	D	D	D	D	D	D	D	D	D	D	D	D	D	D	D	D	D
Novara	-	-	-	-	V	-	-	-	-	-	-	-	-	-	-	-	-	-
Olympus	M, D	M, D	M, D	D	M, D, V	M, D	M, D	D	M, D	M, D	M, D	M, D	M, D	D	D	D	D	D
Olympus Arch	M, D	M, D	M, D	D	M, D, V	M, D	M, D	D	M, D	M, D	M, D	M, D	M, D	-	-	D	-	-
Quadric	M, D	M, D	M, D	D	M, D, V	M, D	M, D	D	M, D	M, D	M, D	M, D	M, D	D	D	D	D	D
Rutledge	M, D	M, D	M, D	D	M, D, V	M, D	M, D	D	M, D	M, D	M, D	M, D	M, D	D	D	D	D	D
Sedona	D	D	D	D	D, V	D	D	D	D	D	D	D	D	D	D	D	D	D
Shasta	-	-	-	-	V	-	-	-	-	-	-	-	-	-	-	-	-	-
Siena	M, D	M, D	M, D	D	M, D	M, D	M, D	D	M, D	M, D	M, D	M, D	M, D	D	D	D	D	D
Summit Hill	M, D	M, D	M, D	D	M, D, V	M, D	M, D	D	M, D	M, D	M, D	M, D	M, D	D	D	D	D	D
Tiara	M, D	M, D	M, D	D	M, D, V	M, D	M, D	D	M, D	M, D	M, D	M, D	M, D	D	D	D	D	D
Tiara Arch	M, D	M, D	M, D	D	M, D, V	M, D	M, D	D	M, D	M, D	M, D	M, D	M, D	-	-	D	-	-
Town&Country	D	D	D	D	D, V	D	D	D	D	D	D	D	D	D	D	D	D	D
Trevant	D	D	D	D	D, V	D	D	D	D	D	D	D	D	D	D	D	D	D
Tuscany	M, D	M, D	M, D	D	M, D	M, D	M, D	D	M, D	M, D	M, D	M, D	M, D	D	D	D	D	D
Waverly	M, D	M, D	M, D	D	M, D, V	M, D	M, D	D	M, D	M, D	M, D	M, D	M, D	D	D	D	D	D
Waverly Arch	M, D	M, D	M, D	D	M, D, V	M, D	M, D	D	M, D	M, D	M, D	M, D	M, D	-	-	D	-	-

D = Door Cut for Glass

M = Mullion Door

V = Vetro Aluminum Door

NEW GLASS INSERT NOMENCLATURE

- Simplifies ordering the glass insert.
- Nomenclature based on cabinet door size and glass insert style.
- Order glass insert under the cabinet door style to get correct glass size.
- Glass inserts are ordered individually. Order 2 inserts for a double door cabinet.
- For use with doors cut for glass and mullion door cabinets.
- See glass specifications section for specific description of glass style and recommendation for use by door style.

Example:

G1530WOVEN

Woven glass insert for use with a 1530 cabinet door.

Use on DCG1530, MW1530, DCG3030, MW3030, etc.

Ordered under a door style (i.e. Waverly or Newbury) to determine glass size.

G	1530	WOVEN
glass insert	cabinet size	insert style code

GLASS INSERT LIST PRICES

Artique		Baroque		Clear		Clear Bevel		Frost Etch medium	
Part #	List	Part #	List	Sell Part #	List	Part #	List	Part #	List
G1524ARTIQUE	179	G1524BAROQUE	235	G1524CLEAR	138	G1524CLBEVEL	259	G1524FROSTETCH	235
G1824ARTIQUE	179	G1824BAROQUE	235	G1824CLEAR	138	G1824CLBEVEL	259	G1824FROSTETCH	235
G1530ARTIQUE	179	G1530BAROQUE	235	G1530CLEAR	138	G1530CLBEVEL	259	G1530FROSTETCH	235
G1830ARTIQUE	179	G1830BAROQUE	235	G1830CLEAR	138	G1830CLBEVEL	259	G1830FROSTETCH	235
G2130ARTIQUE	179	G2130BAROQUE	235	G2130CLEAR	138	G2130CLBEVEL	259	G2130FROSTETCH	235
G2430ARTIQUE	179	G2430BAROQUE	235	G2430CLEAR	138	G2430CLBEVEL	259	G2430FROSTETCH	235
G1536ARTIQUE	206	G1536BAROQUE	288	G1536CLEAR	167	G1536CLBEVEL	321	G1536FROSTETCH	288
G1836ARTIQUE	206	G1836BAROQUE	288	G1836CLEAR	167	G1836CLBEVEL	321	G1836FROSTETCH	288
G2136ARTIQUE	206	G2136BAROQUE	288	G2136CLEAR	167	G2136CLBEVEL	321	G2136FROSTETCH	288
G2436ARTIQUE	206	G2436BAROQUE	288	G2436CLEAR	167	G2436CLBEVEL	321	G2436FROSTETCH	288
G1542ARTIQUE	206	G1542BAROQUE	288	G1542CLEAR	167	G1542CLBEVEL	321	G1542FROSTETCH	288
G1842ARTIQUE	206	G1842BAROQUE	288	G1842CLEAR	167	G1842CLBEVEL	321	G1842FROSTETCH	288
G2142ARTIQUE	206	G2142BAROQUE	288	G2142CLEAR	167	G2142CLBEVEL	321	G2142FROSTETCH	288
G2442ARTIQUE	206	G2442BAROQUE	288	G2442CLEAR	167	G2442CLBEVEL	321	G2442FROSTETCH	288

Glue Chip		Rain		Reeded		Reflections		Saddle	
Part #	List	Part #	List	Part #	List	Part #	List	Part #	List
G1524GLUE	300	G1524RAIN	193	G1524REEDED	233	G1524REFLECT	120	G1524SADDLE	300
G1824GLUE	300	G1824RAIN	193	G1824REEDED	233	G1824REFLECT	120	G1824SADDLE	300
G1530GLUE	300	G1530RAIN	193	G1530REEDED	233	G1530REFLECT	120	G1530SADDLE	300
G1830GLUE	300	G1830RAIN	193	G1830REEDED	233	G1830REFLECT	120	G1830SADDLE	300
G2130GLUE	300	G2130RAIN	193	G2130REEDED	233	G2130REFLECT	120	G2130SADDLE	300
G2430GLUE	300	G2430RAIN	193	G2430REEDED	233	G2430REFLECT	120	G2430SADDLE	300
G1536GLUE	366	G1536RAIN	210	G1536REEDED	254	G1536REFLECT	145	G1536SADDLE	372
G1836GLUE	366	G1836RAIN	210	G1836REEDED	254	G1836REFLECT	145	G1836SADDLE	372
G2136GLUE	366	G2136RAIN	210	G2136REEDED	254	G2136REFLECT	145	G2136SADDLE	372
G2436GLUE	366	G2436RAIN	210	G2436REEDED	254	G2436REFLECT	145	G2436SADDLE	372
G1542GLUE	366	G1542RAIN	210	G1542REEDED	254	G1542REFLECT	145	G1542SADDLE	372
G1842GLUE	366	G1842RAIN	210	G1842REEDED	254	G1842REFLECT	145	G1842SADDLE	372
G2142GLUE	366	G2142RAIN	210	G2142REEDED	254	G2142REFLECT	145	G2142SADDLE	372
G2442GLUE	366	G2442RAIN	210	G2442REEDED	254	G2442REFLECT	145	G2442SADDLE	372

Seedy		Shanghai		Silver Screen		Town Square		Woven	
Part #	List	Part #	List	Part #	List	Part #	List	Part #	List
G1524SEEDY	168	G1524SHANGHAI	300	G1524SILVERSC	259	G1524TOWNSQ	259	G1524WOVEN	451
G1824SEEDY	168	G1824SHANGHAI	300	G1824SILVERSC	259	G1824TOWNSQ	259	G1824WOVEN	451
G1530SEEDY	168	G1530SHANGHAI	300	G1530SILVERSC	259	G1530TOWNSQ	259	G1530WOVEN	451
G1830SEEDY	168	G1830SHANGHAI	300	G1830SILVERSC	259	G1830TOWNSQ	259	G1830WOVEN	451
G2130SEEDY	168	G2130SHANGHAI	300	G2130SILVERSC	259	G2130TOWNSQ	259	G2130WOVEN	451
G2430SEEDY	168	G2430SHANGHAI	300	G2430SILVERSC	259	G2430TOWNSQ	259	G2430WOVEN	451
G1536SEEDY	188	G1536SHANGHAI	372	G1536SILVERSC	321	G1536TOWNSQ	321	G1536WOVEN	519
G1836SEEDY	188	G1836SHANGHAI	372	G1836SILVERSC	321	G1836TOWNSQ	321	G1836WOVEN	519
G2136SEEDY	188	G2136SHANGHAI	372	G2136SILVERSC	321	G2136TOWNSQ	321	G2136WOVEN	519
G2436SEEDY	188	G2436SHANGHAI	372	G2436SILVERSC	321	G2436TOWNSQ	321	G2436WOVEN	519
G1542SEEDY	188	G1542SHANGHAI	372	G1542SILVERSC	321	G1542TOWNSQ	321	G1542WOVEN	519
G1842SEEDY	188	G1842SHANGHAI	372	G1842SILVERSC	321	G1842TOWNSQ	321	G1842WOVEN	519
G2142SEEDY	188	G2142SHANGHAI	372	G2142SILVERSC	321	G2142TOWNSQ	321	G2142WOVEN	519
G2442SEEDY	188	G2442SHANGHAI	372	G2442SILVERSC	321	G2442TOWNSQ	321	G2442WOVEN	519



Victoria Patina		Victorian Zinc		Vintage Patina		Vintage Zinc	
Part #	List	Part #	List	Part #	List	Part #	List
G1524VICTORP	513	G1524VICTORZ	489	G1524VINTAGEP	451	G1524VINTAGEZ	430
G1824VICTORP	513	G1824VICTORZ	489	G1824VINTAGEP	451	G1824VINTAGEZ	430
G1530VICTORP	513	G1530VICTORZ	489	G1530VINTAGEP	451	G1530VINTAGEZ	430
G1830VICTORP	513	G1830VICTORZ	489	G1830VINTAGEP	451	G1830VINTAGEZ	430
G2130VICTORP	513	G2130VICTORZ	489	G2130VINTAGEP	451	G2130VINTAGEZ	430
G2430VICTORP	513	G2430VICTORZ	489	G2430VINTAGEP	451	G2430VINTAGEZ	430
G1536VICTORP	590	G1536VICTORZ	562	G1536VINTAGEP	519	G1536VINTAGEZ	495
G1836VICTORP	590	G1836VICTORZ	562	G1836VINTAGEP	519	G1836VINTAGEZ	495
G2136VICTORP	590	G2136VICTORZ	562	G2136VINTAGEP	519	G2136VINTAGEZ	495
G2436VICTORP	590	G2436VICTORZ	562	G2436VINTAGEP	519	G2436VINTAGEZ	495
G1542VICTORP	590	G1542VICTORZ	562	G1542VINTAGEP	519	G1542VINTAGEZ	495
G1842VICTORP	590	G1842VICTORZ	562	G1842VINTAGEP	519	G1842VINTAGEZ	495
G2142VICTORP	590	G2142VICTORZ	562	G2142VINTAGEP	519	G2142VINTAGEZ	495
G2442VICTORP	590	G2442VICTORZ	562	G2442VINTAGEP	519	G2442VINTAGEZ	495

Windsor Patina		Windsor Zinc	
Part #	List	Part #	List
G1524WINDSORP	604	G1524WINDSORZ	575
G1824WINDSORP	604	G1824WINDSORZ	575
G1530WINDSORP	604	G1530WINDSORZ	575
G1830WINDSORP	604	G1830WINDSORZ	575
G2130WINDSORP	604	G2130WINDSORZ	575
G2430WINDSORP	604	G2430WINDSORZ	575
G1536WINDSORP	694	G1536WINDSORZ	661
G1836WINDSORP	694	G1836WINDSORZ	661
G2136WINDSORP	694	G2136WINDSORZ	661
G2436WINDSORP	694	G2436WINDSORZ	661
G1542WINDSORP	694	G1542WINDSORZ	661
G1842WINDSORP	694	G1842WINDSORZ	661
G2142WINDSORP	694	G2142WINDSORZ	661
G2442WINDSORP	694	G2442WINDSORZ	661

Glass Shelving			
Part #	Use with	Glass Size	List
G1SHELF	15" wide cabinets	13 1/2 X 10 5/8"	138
G18SHELF	18" wide cabinets	16 1/2 X 10 5/8"	148
G21SHELF	21" wide cabinets	19 1/2 X 10 5/8"	153
G24SHELF	24" wide corner walls	22 5/8" x 22 5/8"	237
G30SHELF	30" wide cabinets	28 1/2 X 10 5/8"	181
G36SHELF	36" wide cabinets	34 1/2 X 10 5/8"	197
G42SHELF	42" wide cabinets	40 1/2 X 10 5/8"	208











All shelves are 1/4" Tempered, Pencil Polished on all 4 edges.
 Priced and Packaged as 2 glass shelves per box.
 42" High Wall Cabinets require two (2) boxes of shelves.

PRODUCT	CUBIC FEET	WEIGHT	CHERRY				MAPLE											
			CIMARRON	ARBORCREST	OLYMPUS SQ/ARCH	LACERISE SQ/ARCH	NOVARA	NEWBURY	CARUTH	CALIBRA II	RUTLEDGE SLAB	RUTLEDGE 5PC	TREVANT SLAB	TREVANT 5PC	BERKSHIRE SQ/ARCH	TIARA SQ/ARCH	WAVERLY SQ/ARCH	LEIGHTON TOWN&COUNTRY
DOORS CUT FOR GLASS			<i>Not available in Calibra II</i>															
DCGI524 L or R	1.1	2	261	276	294	294	-	219	254	230	230	262	262	254	256	256	314	336
DCGI824 L or R	1.1	3	266	281	300	300	-	221	259	233	233	266	266	259	260	260	321	344
DCGI530 L or R	0.5	2	304	323	343	343	-	254	297	267	267	306	306	297	299	299	368	394
DCGI830 L or R	0.5	4	316	334	357	357	-	262	307	276	276	315	315	307	308	308	379	405
DCG2130 L or R	0.6	4	322	341	365	365	-	268	312	282	282	322	322	312	313	313	385	414
DCGC2430 L or R	0.5	3	311	329	350	350	-	257	303	271	271	310	310	303	302	302	373	400
DCGI536 L or R	0.7	3	359	378	404	404	-	295	347	311	311	357	357	347	347	347	428	460
DCGI836 L or R	0.7	4	371	392	418	418	-	308	360	324	324	370	370	360	363	363	446	478
DCG2136 L or R	0.9	4	378	401	427	427	-	314	369	330	330	377	377	369	369	369	454	488
DCGC2436 L or R	0.7	3	365	384	410	410	-	303	352	319	319	363	363	352	356	356	437	469
DCGI542 L or R	0.7	3	423	447	477	477	-	351	411	369	369	422	422	411	412	412	508	543
DCGI842 L or R	0.7	4	437	463	494	494	-	364	426	383	383	439	439	426	428	428	527	565
DCG2142 L or R	0.9	5	445	470	501	501	-	370	433	389	389	445	445	433	435	435	535	573
DCGC2442 L or R	0.7	4	430	455	486	486	-	355	418	374	374	429	429	418	418	418	516	553
SINGLE DOOR CUT FOR GLASS WALL CABINETS			<i>Not available in Calibra II</i>															
DGWI524 L or R	3.4	25	330	349	373	373	-	275	321	289	289	329	329	321	322	322	397	425
DGWI824 L or R	4.0	27	366	386	413	413	-	304	353	320	320	364	364	353	356	356	438	470
DGWI530 L or R	4.1	31	377	399	426	426	-	313	368	329	329	376	376	368	368	368	453	487
DGWI830 L or R	4.9	34	394	416	445	445	-	327	383	344	344	394	394	383	383	383	473	508
DGW2130 L or R	5.6	40	428	454	484	484	-	354	416	373	373	428	428	416	417	417	514	550
DGWI536 L or R	4.9	35	506	536	572	572	-	420	493	442	442	506	506	493	495	495	609	653
DGWI836 L or R	5.8	40	541	572	610	610	-	448	525	472	472	540	540	525	527	527	648	695
DGW2136 L or R	6.7	44	562	595	634	634	-	466	546	491	491	561	561	546	549	549	676	724
DGWI542 L or R	5.7	31	514	544	581	581	-	427	502	449	449	513	513	502	502	502	618	663
DGWI842 L or R	6.7	34	549	581	619	619	-	456	534	480	480	547	547	534	536	536	659	706
DGW2142 L or R	7.7	40	571	604	643	643	-	474	554	499	499	571	571	554	558	558	685	735
DOUBLE DOOR CUT FOR GLASS WALL CABINETS			<i>Not available in Calibra II</i>															
DGW3024	6.4	38	575	608	647	647	-	477	559	502	502	575	575	559	562	562	691	741
DGW3624	7.6	47	637	673	717	717	-	527	618	555	555	634	634	618	619	619	763	818
DGW3030	7.9	53	661	698	745	745	-	548	641	577	577	660	660	641	644	644	793	851
DGW3630	9.3	60	724	766	817	817	-	601	704	633	633	724	724	704	706	706	871	932
DGW4230	10.8	67	806	851	909	909	-	668	782	703	703	805	805	782	785	785	968	1038
DGW3036	9.3	57	884	935	996	996	-	732	859	770	770	883	883	859	861	861	1061	1138
DGW3636	11.1	65	976	1030	1099	1099	-	808	947	851	851	973	973	947	950	950	1169	1254
DGW4236	12.9	72	1079	1141	1216	1216	-	895	1047	942	942	1077	1077	1047	1052	1052	1295	1389
DGW3042	10.8	61	897	949	1013	1013	-	744	872	783	783	897	897	872	874	874	1077	1155
DGW3642	12.9	69	989	1046	1116	1116	-	820	961	863	863	987	987	961	964	964	1188	1273
DGW4242	15.0	76	1095	1158	1234	1234	-	909	1063	957	957	1094	1094	1063	1068	1068	1315	1410

 SHADED PRODUCT SKU'S ARE FOR BASIC ITEMS (TRIMS AND ACCESSORIES). ORDER BY SPECIES STYLE CODE.
 ALL PRICES, MODEL SIZES AND SPECIFICATIONS ARE SUBJECT TO CHANGE WITHOUT NOTICE. REFER TO PRODUCT SPECIFICATIONS GUIDE FOR SPECIFIC PRODUCT AVAILABILITY BY DOOR STYLE AND SERIES. SERIES UPCHARGES WILL BE ROUNDED TO THE NEAREST DOLLAR.
 DOOR STYLE IS NOW AVAILABLE WITH DOORS CUT FOR GLASS CABINETS.

PRODUCT	RUSTIC ALDER			OAK		BIRCH		PL HWD	LAMINATE / THERMOFOIL				CONSTRUCTION UPGRADES						ALLWOOD / EXTREME SERIES
	ARBORCREST	LACERISE SLAB SQ/ARCH	LACERISE 5PC SQ/ARCH	BRANFORD	HAMPTON SQ/ARCH	SIENA	TUSCANY	CORONET	SHASTA	SUMMIT HILL	MAYFAIR	QUADRIC	DOVETAIL DRAWERS	SOFT-CLOSE DRAWER	DELUXE END PANELS (Premier)	DELUXE END PANELS (Allwood, Extreme, Origins)	ALTERED DEPTH	FULL DEPTH SHELF	
DOORS CUT FOR GLASS																			
DCGI524 L or R	263	280	280	213	213	206	223	-	-	202	218	222	-	-	-	-	-	-	○
DCGI824 L or R	266	284	284	217	217	212	229	-	-	206	221	226	-	-	-	-	-	-	○
DCGI530 L or R	307	326	326	249	249	243	262	-	-	238	255	260	-	-	-	-	-	-	○
DCGI830 L or R	317	339	339	258	258	251	272	-	-	246	266	271	-	-	-	-	-	-	○
DCG2130 L or R	324	347	347	263	263	256	276	-	-	250	270	275	-	-	-	-	-	-	○
DCGC2430 L or R	313	333	333	254	254	247	266	-	-	242	260	265	-	-	-	-	-	-	○
DCGI536 L or R	359	384	384	294	294	284	307	-	-	278	299	305	-	-	-	-	-	-	○
DCGI836 L or R	373	397	397	303	303	295	318	-	-	289	309	315	-	-	-	-	-	-	○
DCG2136 L or R	381	405	405	308	308	300	325	-	-	294	318	324	-	-	-	-	-	-	○
DCGC2436 L or R	365	390	390	297	297	290	313	-	-	283	304	310	-	-	-	-	-	-	○
DCGI542 L or R	425	454	454	346	346	336	364	-	-	330	354	361	-	-	-	-	-	-	○
DCGI842 L or R	439	470	470	356	356	347	375	-	-	340	366	373	-	-	-	-	-	-	○
DCG2142 L or R	446	476	476	365	365	355	383	-	-	346	372	380	-	-	-	-	-	-	○
DCGC2442 L or R	433	462	462	351	351	341	370	-	-	334	360	367	-	-	-	-	-	-	○
SINGLE DOOR CUT FOR GLASS WALL CABINETS																			
DGW1524 L or R	332	354	354	270	270	261	283	-	-	257	275	281	-	-	47	19	120	-	●
DGW1824 L or R	367	392	392	297	297	290	313	-	-	283	306	312	-	-	47	19	120	-	●
DGW1530 L or R	379	404	404	308	308	300	325	-	-	293	315	321	-	-	47	19	120	-	●
DGW1830 L or R	395	422	422	322	322	314	338	-	-	307	329	336	-	-	47	19	120	-	●
DGW2130 L or R	431	460	460	350	350	340	368	-	-	333	358	365	-	-	47	19	120	-	●
DGW1536 L or R	509	543	543	414	414	403	436	-	-	394	423	432	-	-	47	19	170	-	●
DGW1836 L or R	543	580	580	442	442	430	465	-	-	420	451	460	-	-	47	19	170	-	●
DGW2136 L or R	565	602	602	458	458	446	482	-	-	437	469	479	-	-	47	19	170	-	●
DGW1542 L or R	517	552	552	420	420	409	443	-	-	400	430	439	-	-	47	19	170	-	●
DGW1842 L or R	552	589	589	449	449	437	471	-	-	427	458	467	-	-	47	19	170	-	●
DGW2142 L or R	573	610	610	466	466	452	488	-	-	444	475	485	-	-	47	19	170	-	●
DOUBLE DOOR CUT FOR GLASS WALL CABINETS																			
DGW3024	577	615	615	469	469	454	493	-	-	447	480	490	-	-	47	19	170	-	●
DGW3624	640	681	681	519	519	505	545	-	-	495	531	542	-	-	47	19	170	-	●
DGW3030	663	708	708	540	540	525	567	-	-	513	553	564	-	-	47	19	170	-	●
DGW3630	727	777	777	591	591	577	621	-	-	564	606	618	-	-	47	19	170	-	●
DGW4230	809	864	864	659	659	640	694	-	-	626	672	686	-	-	47	19	170	-	●
DGW3036	888	947	947	721	721	702	760	-	-	687	738	753	-	-	47	19	190	-	●
DGW3636	978	1044	1044	795	795	773	835	-	-	757	814	831	-	-	47	19	190	-	●
DGW4236	1085	1155	1155	880	880	855	924	-	-	839	901	919	-	-	47	19	190	-	●
DGW3042	901	962	962	732	732	713	770	-	-	698	750	765	-	-	47	19	190	-	●
DGW3642	994	1060	1060	807	807	785	847	-	-	769	826	843	-	-	47	19	190	-	●
DGW4242	1101	1172	1172	893	893	869	939	-	-	851	914	933	-	-	47	19	190	-	●

- PRODUCT AVAILABLE IN ALLWOOD (+12% UPCHARGE) OR EXTREME (+14% UPCHARGE) TO PUBLISHED PREMIER PRICE.
- PRODUCT AVAILABLE AT SAME PRICE AS PREMIER PUBLISHED PRICE.

PRODUCT	CUBIC FEET	WEIGHT	CHERRY				MAPLE											
			 CIMARRON	ARBORCREST	 OLYMPUS SQ/ARCH	 LACERISE SQ/ARCH	NOVARA	 NEWBURY	 CARUTH	 CALIBRA II RUTLEDGE SLAB	 RUTLEDGE 5PC	TREVANT SLAB	TREVANT 5PC	 BERKSHIRE SQ/ARCH	 TIARA SQ/ARCH	 WAVERLY SQ/ARCH	LEIGHTON TOWN&COUNTRY	SEDONA ^(+DD)
THREE DOOR CUT FOR GLASS WALL CABINETS			<i>Not available in Calibra II</i>															
DGW4524-3	9.4	53	806	852	909	909	-	659	771	694	694	794	794	771	775	775	956	1022
DGW4824-3	10.0	56	860	911	969	969	-	706	827	743	743	850	850	827	829	829	1022	1095
DGW4530-3	11.6	72	863	912	972	972	-	689	806	725	725	829	829	806	809	809	996	1067
DGW4830-3	12.3	77	892	944	1006	1006	-	713	834	751	751	856	856	834	836	836	1031	1107
DGW4536-3	13.8	80	1169	1238	1319	1319	-	970	1134	1021	1021	1167	1167	1134	1141	1141	1404	1507
DGW4836-3	14.7	83	1192	1261	1345	1345	-	991	1161	1043	1043	1194	1194	1161	1164	1164	1434	1535
DGW4542-3	16.0	84	1188	1257	1341	1341	-	983	1152	1035	1035	1186	1186	1152	1157	1157	1426	1528
DGW4842-3	17.0	86	1211	1278	1366	1366	-	1005	1178	1058	1058	1212	1212	1178	1179	1179	1456	1558
SINGLE DOOR CUT FOR GLASS PENINSULA WALL CABINETS			<i>Not available in Calibra II</i>															
PDGW1824 L or R	5.5	29	608	643	685	685	-	504	590	530	530	608	608	590	592	592	729	783
PDGW1830 L or R	6.8	34	778	821	876	876	-	646	755	680	680	776	776	755	758	758	934	1001
PDGW2130 L or R	6.8	40	806	851	909	909	-	668	782	703	703	805	805	782	785	785	968	1038
DOUBLE DOOR CUT FOR GLASS PENINSULA WALL CABINETS			<i>Not available in Calibra II</i>															
PDGW3024	6.8	40	874	923	986	986	-	724	849	762	762	871	871	849	851	851	1049	1123
PDGW3624	8.0	50	989	1046	1116	1116	-	820	961	863	863	987	987	961	964	964	1188	1273
PDGW3030	8.3	50	1077	1138	1213	1213	-	893	1044	940	940	1074	1074	1044	1048	1048	1291	1384
PDGW3630	9.9	53	1244	1317	1403	1403	-	1033	1209	1087	1087	1244	1244	1209	1213	1213	1495	1602
PDGW4230	11.5	59	1415	1497	1596	1596	-	1175	1374	1237	1237	1413	1413	1374	1379	1379	1699	1821
SINGLE DOOR CUT FOR GLASS CORNER WALL CABINETS			<i>Not available in Calibra II</i>															
DGCW2430 L or R	11.4	57	574	606	646	646	-	476	559	501	501	574	574	559	561	561	690	740
DGCW2436 L or R	13.6	59	632	667	712	712	-	523	615	551	551	632	632	615	617	617	759	814
DGCW2442 L or R	15.7	61	695	734	782	782	-	577	675	607	607	694	694	675	678	678	834	896
DGCW2730 L or R	14.2	59	695	734	782	782	-	577	675	607	607	694	694	675	678	678	834	896
DGCW2736 L or R	17.0	62	765	808	860	860	-	634	743	667	667	764	764	743	745	745	918	985
DGCW2742 L or R	19.7	64	842	889	946	946	-	697	817	734	734	840	840	817	819	819	1010	1084
MOLDINGS																		
LOCM8S	0.1	2	66	66	66	66	64	64	64	64	64	64	64	64	64	64	64	64
CHR8S	0.1	3	185	185	185	185	180	180	180	180	180	180	180	180	180	180	180	180
CHB8S	0.1	2	203	203	203	203	198	198	198	198	198	198	198	198	198	198	198	198

SHADED PRODUCT SKU'S ARE FOR BASIC ITEMS (TRIMS AND ACCESSORIES). ORDER BY SPECIES STYLE CODE.
 ALL PRICES, MODEL SIZES AND SPECIFICATIONS ARE SUBJECT TO CHANGE WITHOUT NOTICE. REFER TO PRODUCT SPECIFICATIONS GUIDE
 FOR SPECIFIC PRODUCT AVAILABILITY BY DOOR STYLE AND SERIES. SERIES UPCHARGES WILL BE ROUNDED TO THE NEAREST DOLLAR.

 DOOR STYLE IS NOW AVAILABLE WITH DOORS CUT FOR GLASS CABINETS.

PREMIER

PRICE LIST EFFECTIVE OCTOBER 14, 2013

PRODUCT	RUSTIC ALDER			OAK		BIRCH		PL HWD	LAMINATE / THERMOFOIL				CONSTRUCTION UPGRADES						ALLWOOD / EXTREME SERIES
	ARBORCREST	LACERISE SLAB SQ/ARCH	LACERISE 5PC SQ/ARCH	BRANFORD	HAMPTON SQ/ARCH	SIENA	TUSCANY	CORONET	SHASTA	SUMMIT HILL	MAYFAIR	QUADRIC	DOVETAIL DRAWERS	SOFT-CLOSE DRAWER	DELUXE END PANELS (Premier)	DELUXE END PANELS (Allwood, Extreme, Origins)	ALTERED DEPTH	FULL DEPTH SHELF	
THREE DOOR CUT FOR GLASS WALL CABINETS																			
DGW4524-3	810	864	864	653	653	631	682	-	-	618	664	678	-	-	47	19	170	-	●
DGW4824-3	865	921	921	694	694	675	730	-	-	663	711	726	-	-	47	19	170	-	●
DGW4530-3	866	923	923	669	669	649	701	-	-	636	684	698	-	-	47	19	-	-	●
DGW4830-3	897	956	956	694	694	676	732	-	-	665	712	727	-	-	47	19	-	-	●
DGW4536-3	1175	1254	1254	958	958	933	1006	-	-	908	977	997	-	-	47	19	-	-	●
DGW4836-3	1198	1277	1277	976	976	948	1022	-	-	930	997	1017	-	-	47	19	-	-	●
DGW4542-3	1194	1274	1274	969	969	945	1021	-	-	923	992	1012	-	-	47	19	-	-	●
DGW4842-3	1214	1298	1298	988	968	961	1039	-	-	942	1011	1032	-	-	47	19	-	-	●
SINGLE DOOR CUT FOR GLASS PENINSULA WALL CABINETS																			
PDGW1824 L or R	610	651	651	486	486	482	522	-	-	472	507	517	-	-	47	19	-	-	●
PDGW1830 L or R	779	832	832	621	621	617	666	-	-	605	650	663	-	-	47	19	-	-	●
PDGW2130 L or R	809	864	864	646	646	640	694	-	-	626	672	686	-	-	47	19	-	-	●
DOUBLE DOOR CUT FOR GLASS PENINSULA WALL CABINETS																			
PDGW3024	878	936	936	700	700	695	751	-	-	678	729	744	-	-	47	19	-	-	●
PDGW3624	994	1060	1060	791	791	785	847	-	-	769	826	843	-	-	47	19	-	-	●
PDGW3030	1081	1153	1153	861	861	854	922	-	-	836	899	917	-	-	47	19	-	-	●
PDGW3630	1251	1333	1333	997	997	989	1069	-	-	967	1039	1060	-	-	47	19	-	-	●
PDGW4230	1422	1516	1516	1132	1132	1124	1214	-	-	1099	1183	1207	-	-	47	19	-	-	●
SINGLE DOOR CUT FOR GLASS CORNER WALL CABINETS																			
DGCW2430 L or R	575	614	614	469	469	454	493	-	-	446	478	488	-	-	47	19	-	-	●
DGCW2436 L or R	634	676	676	516	516	500	542	-	-	489	527	538	-	-	47	19	-	-	●
DGCW2442 L or R	698	743	743	568	568	550	596	-	-	539	580	592	-	-	47	19	-	-	●
DGCW2730 L or R	698	743	743	568	568	550	596	-	-	539	580	592	-	-	47	19	-	-	●
DGCW2736 L or R	768	817	817	625	625	605	656	-	-	593	638	651	-	-	47	19	-	-	●
DGCW2742 L or R	845	898	898	688	688	666	722	-	-	652	701	715	-	-	47	19	-	-	●
MOLDINGS																			
LOCM8S	66	66	66	49	49	64	64	49	-	-	-	-	-	-	-	-	-	-	○
CHR8S	190	190	190	140	140	180	180	140	-	-	-	-	-	-	-	-	-	-	○
CHB8S	209	209	209	154	154	198	198	154	-	-	-	-	-	-	-	-	-	-	○

- PRODUCT AVAILABLE IN ALLWOOD (+12% UPCHARGE) OR EXTREME (+14% UPCHARGE) TO PUBLISHED PREMIER PRICE.
- PRODUCT AVAILABLE AT SAME PRICE AS PREMIER PUBLISHED PRICE.